

TL0375J

2.0 – 5.0 GHz GaAs Ultra Low Noise Amplifier

Application Note: TL0375J EVB A

Application Note

3300MHz~3800MHz

5.0V 60mA

Rev-1.1

List of Contents

- 1 General Description
- 2 TL0375J-EVB-A Board Details
- 3 TL0375J -EVB-A Bill of Material
- 4 TL0375J -EVB-A Biasing sequence
- 5 TL0375J -EVB-A Board Measurement Summary
- 6 TL0375J -EVB-A Board Measurement Results

1. General Description

The TL0375J is a broadband, ultra-low Noise Amplifier (LNA) providing high gain and linearity. With a simple input and output match, this LNA can be tuned for different frequency bands targeting LTE (small cells and infrastructure) and any other applications requiring low noise, high gain, and linearity. For <3GHz frequency band, TL0374J can be considered. The TL0375J is packaged in a compact, low-cost Dual Flat No Lead (DFN) 2x2x0.75mm, 8 pin plastic package.

TL0375J-EVB-A is an evaluation board specially tuned for frequency range of 3300MHz~3800MHz applications. Its high gain, low noise performance makes it suitable for application of public safety, radar, tactical radio, IoT, Cellular infrastructure, LTE etc.

2. TL0375J-EVB-A Board Details

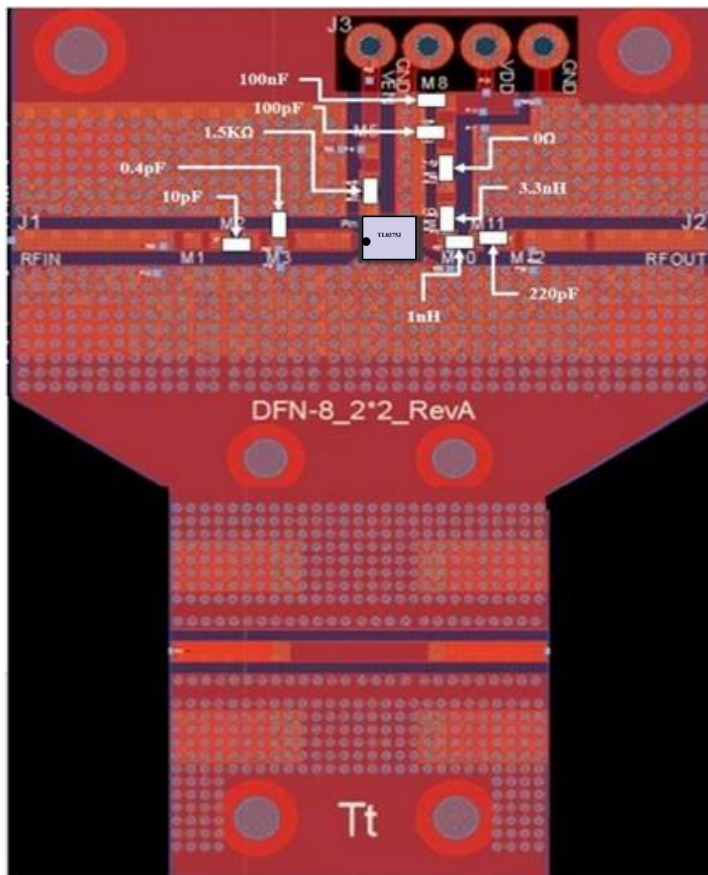
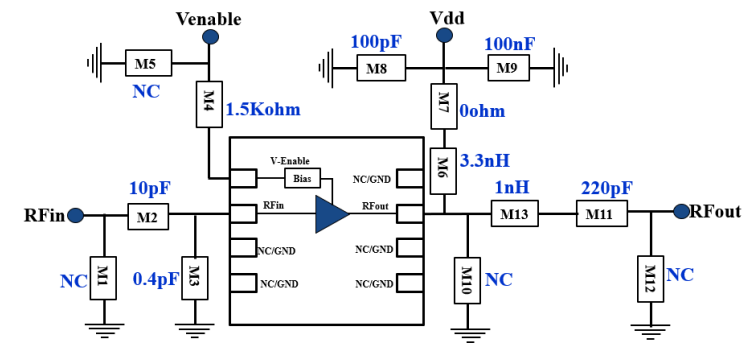

Figure 2.1 TL0375J-EVB-A 3300MHz ~ 3800MHz Schematic and EVB Layout

3. TL0375J-EVB-A Bill of Material

Component ID	Value	Manufacturer	Recommended Part Number
M2	10pF	Murata	GJM1555C1H100JB01
M3	0.4pF	Murata	GJM1555C1HR40BB01
M4	1.5K Ω	Panasonic	ERJ-2RKF1501X
M6	3.3nH	Coil craft	0402HP-3N3XGE
M8	100pF	AVX	04025A101JAT4A
M7	0 Ω	Panasonic	ERJ-2GE0R00X
M9	100nF	TDK	C1005X7R1H104K050BE
M11	220pF	Kemet	C0402C221K5GACAUTO
M13	1nH	Coil craft	0402HP-1N0XJE
Q1	GaAs LNA	Tagore Technology	TL0375J
PCB		Rogers RO4350B, 20 mils, 1 oz copper	

Table 3.1 TL0375J-EVB-A BOM

4. TL0375J-EVB-A Biasing Sequence

Turn ON Device	Turn OFF Device
1. Set Venable to +5V 2. Set V _{DD} to +5V 3. Device will draw required I _{DQ} current 4. Apply RF power	1. Turn RF power off 2. Turn off V _{DD} 3. Turn off Venable

Table 4.1 TL0375J-EVB-A Bias and Sequencing

5. TL0375J-EVB-A Board Measurement Summary

Frequency (MHz)	EVB Noise Figure (dB)	Gain (dB)	OP1 (dBm)	OIP3(dBm) Fspacing:1MHz 0dBm Pout/tone	S11 (dB)	S22 (dB)	Mu1
3300	0.5	18.2	19.3	33.5	-14.7	-8.4	1.2
3400	0.5	18.1	20.0	33.4	-15.4	-8.9	1.2
3500	0.5	17.9	19.8	33.0	-15.8	-9.5	1.2
3600	0.5	17.7	20.4	32.6	-16.0	-10.1	1.2
3700	0.5	17.6	19.5	32.6	-16.0	-10.4	1.2
3800	0.6	17.4	19.7	32.9	-16.0	-10.6	1.2

Table 5.1 TL0375J-EVB-A Electrical Characteristics Summary

6. TL0375J-EVB-A Test Results

All the tests are carried out at room temperature.

6.1. S parameters

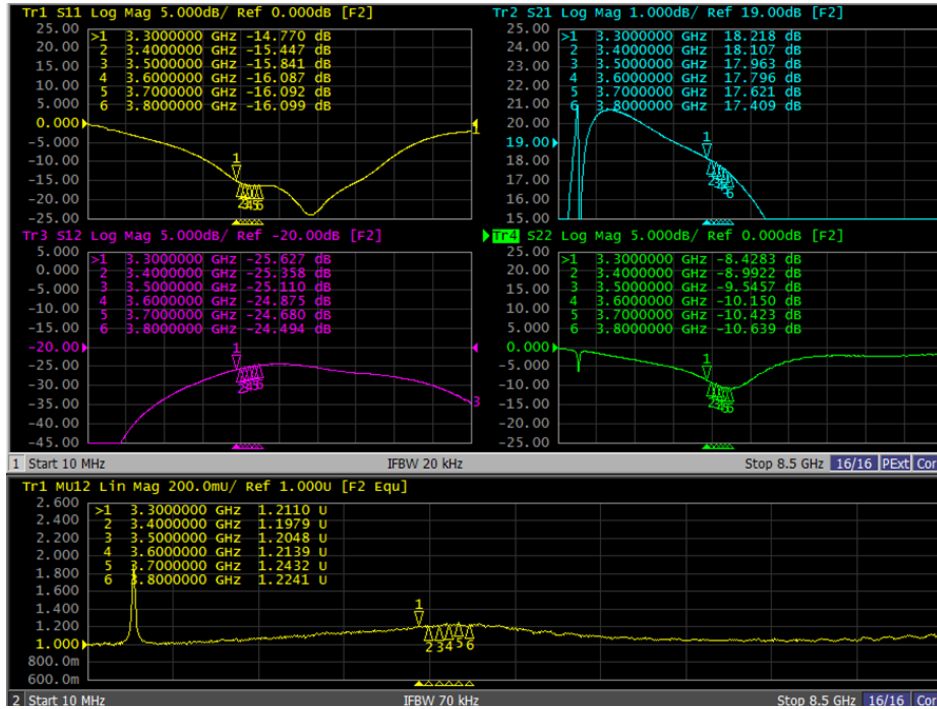

Figure 6.1.1. S parameters of TL0375J-EVB-A

6.2. EVB Noise Figure

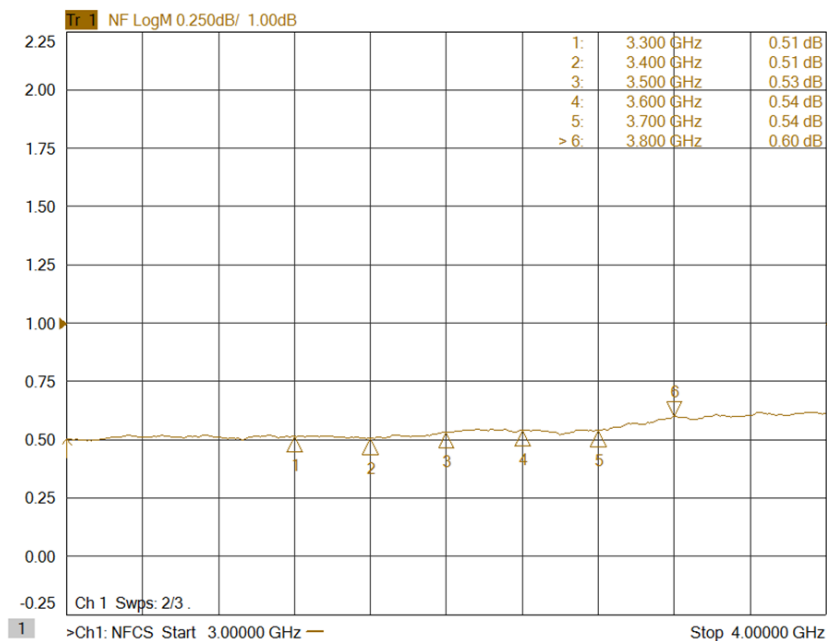

Figure 6.2.1. EVB Noise Figure mode of TL0375J-EVB-A

6.3. Large Signal Test Results

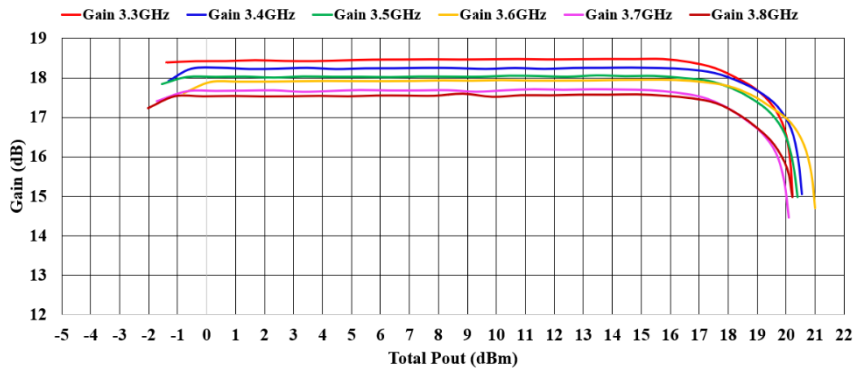

Figure 6.3.1. Gain Vs Pout of TL0375J-EVB-A

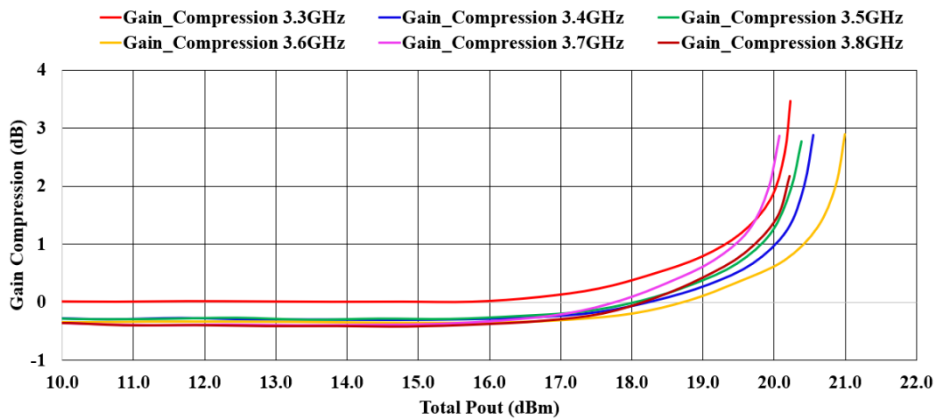

Figure 6.3.2. Gain compression Vs Pout of TL0375J-EVB-A

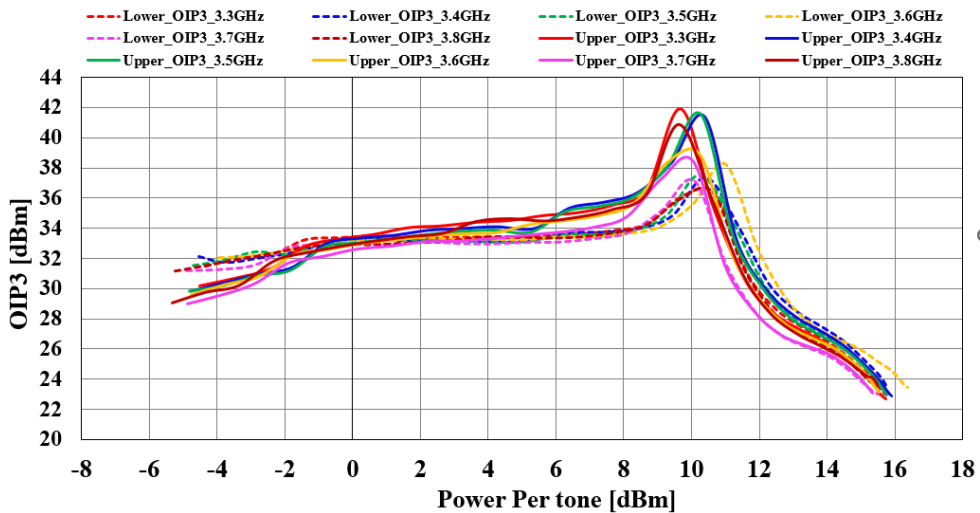

Figure 6.3.3. Output 3rd Order Intercept Point of TL0375J-EVB-A

Edition Revision 1.1 - 2023-11-08

Published by

Tagore Technology Inc.

601 W Campus Dr. Ste C1

Arlington Heights, IL 60004, USA

©2020 All Rights Reserved

Legal Disclaimer

The information provided in this document shall in no event be regarded as a guarantee of conditions or characteristics. Tagore Technology assumes no responsibility for the consequences of the use of this information, nor for any infringement of patents or of other rights of third parties which may result from the use of this information. No license is granted by implication or otherwise under any patent or patent rights of Tagore Technology. The specifications mentioned in this document are subject to change without notice.

Information

For further information on technology, delivery terms and conditions and prices, please contact Tagore Technology: support@tagoretech.com.